

BERT

BIT ERROR RATE TESTER

SPECIFICATION SHEET

AVAILABLE IN PXI

AVAILABLE IN MATRIQ

Quantifi Photonics' BERT is a 2 or 4-channel PPG and Error Detector for the design, characterization and production of optical transceivers and opto-electrical components at data rates up to 30 Gb/s.

With scalability and exceptional signal fidelity, it is a cost-effective test solution for 400 Gb/s communication eco-systems.



Programmable de-emphasis and CTLE processor.

Programmable PPG Tx de-emphasis and error detector receiver continuous-time linear equalizer (CTLE) allow the user to compensate for finite coaxial cable interconnect loss.

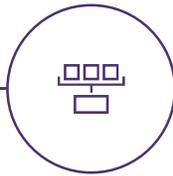

Single platform testing.

Conduct all your DUT characterization on one platform and spend less time switching cables and patchcords between instruments.

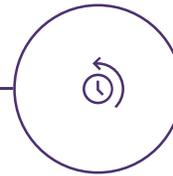

Built-in clock recovery.

4-channel simultaneous testing in a Integrated CDR makes the BERT a versatile and easy-to-use instrument. No need for additional clock recovery hardware.



Simple control with intuitive GUI.

Save time and reduce complexity with the easy-to-use GUI. Control all channels and functions from its single panel interface.



Internal clock synthesizer.

An integrated clock synthesizer for additional convenience and hassle-free operation.

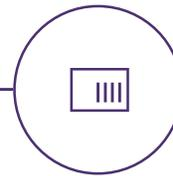

Extremely high channel density in PXI.

With up to 4-channels per single-slot PXIe module, fit up to 68 synchronized channels per single PXIe mainframe.

TARGET APPLICATIONS

- Multi-channel BER Tester for 30 Gbps
- Active optical cable testing
- High speed SerDes characterization

EXAMPLE DATA SIGNAL

Example of 26 Gbps PRBS data signal generated by the BERT-1001

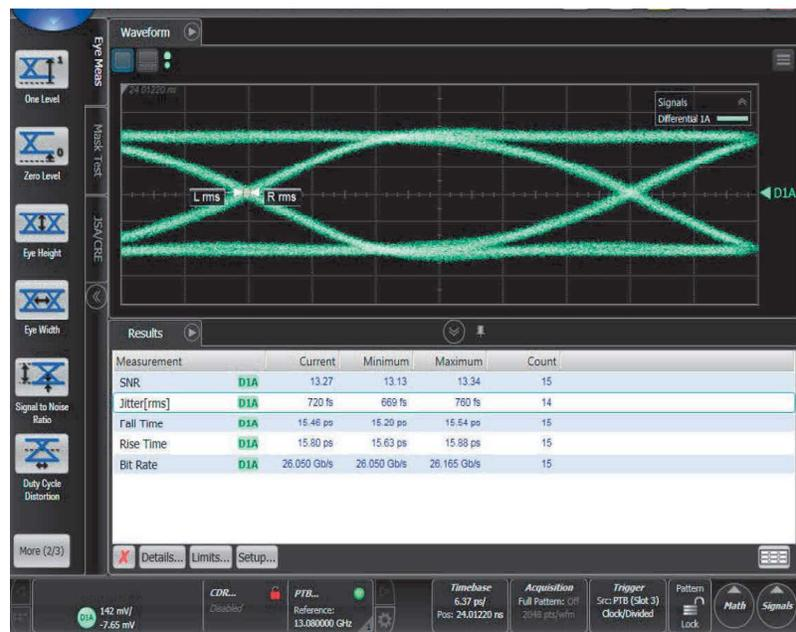

CHOOSE YOUR FORM FACTOR

PXIe – MODULAR

Our expanding range of PXIe optical test solutions are used by customers in mixed-signal test and measurement systems, reducing complexity, lowering the cost of test and accelerating time to market.

- Multi vendor, open standard with over 2500 PXI modules available
- Advanced timing and synchronization capabilities across instruments
- Low latency, high performance processing and fast data throughput
- Design and build scalable, high channel count systems
- Small footprint and lower power consumption



MATRIQ – COMPACT & PORTABLE

The MATRIQ series provides the same high-performance test capabilities of our PXIe modules in an compact benchtop design. MATRIQ instruments are simple to setup and easy to operate, making them the perfect choice for your optical lab or test bench.

- Same performance and control as our PXIe modules
- Plug and play with USB or Ethernet connectivity
- Control via the web-based GUI, COHESIONUI or SCPI commands
- Compact and portable design saves benchtop space



BERT TECHNICAL SPECIFICATIONS

PXI - MODULAR

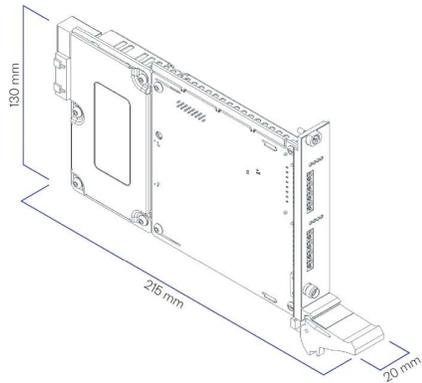

BERT-1005-4-PXIE

MATRIQ - COMPACT & PORTABLE



BERT-1005-4-MTRQ

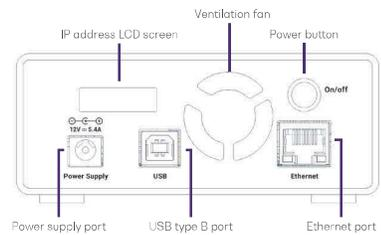
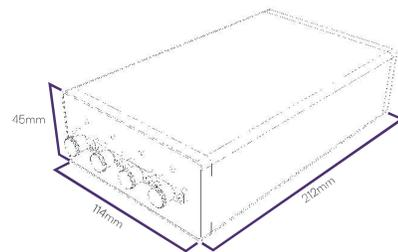

BERT TECHNICAL SPECIFICATIONS

General Specifications	PXI	MATRIQ
Bus connection	PXIe	USB and Ethernet
Slot count	1	-
Dimensions (H x W x D)	130 x 20 x 215 mm 5.1 x 0.8 x 8.5 inches	53 x 120 x 202 mm 2.1 x 4.7 x 8.0 inches
Weight	~ 250 grams ~ 0.55 lbs	~ 1.1 kg ~ 2.4 lbs
Operating temperature range	5°C to 45°C 41°F to 113°F	5°C to 45°C 41°F to 113°F
Storage temperature range	-40°C to 70°C -40°F to 158°F	-40°C to 70°C -40°F to 158°F

Power Specifications	PXI	MATRIQ
AC input voltage range	Please refer to the latest PXI Express Hardware Specifications published by the PXI Systems Alliance.	90 to 264 VAC
AC input current		1.3A (115Vac), 0.9A (230Vac)
AC frequency range		47 to 63 Hz
DC output voltage		12V
DC output current max		5.41A
Dimensions (LxWxH)		4.58 x 2.06 x 1.23" (116.3 x 52.4 x 31.3 mm)

Model Number	1001	1005	1001	1005
Number of channels	2	4	2	4
RF output	Differential	Differential	Differential	Differential
RF connector	1 x breakout cable with 8 x 2.92 mm connectors	2 x breakout cables with 8 x SMA connectors	1 x breakout cable with 8 x 2.92 mm connectors	2 x breakout cables with 8 x SMA connectors
Impedance	100 ohms between differential outputs	100 ohms between differential outputs	100 ohms between differential outputs	100 ohms between differential outputs
Data coding	NRZ	NRZ	NRZ	NRZ
Data rate	0.48 to 30 Gbps	1.25 to 14.50 Gbps	0.48 to 30 Gbps	1.25 to 14.50 Gbps
Data rate step size	1 kbps	2 kbps	1 kbps	2 kbps
PRBS patterns	2n-1, n = 9, 15 or 31	2n-1, n = 9, 15 or 31	2n-1, n = 9, 15 or 31	2n-1, n = 9, 15 or 31
Output amplitude (mV differential)	Adjustable 200 to 1100	Adjustable 250 to 1100	Adjustable 200 to 1100	Adjustable 250 to 1100
Output amplitude steps (mV differential)	5	5	5	5
Rise/fall time (20% to 80%)	< 18 ps	< 18 ps	< 18 ps	< 18 ps
Intrinsic jitter	< 850 fs rms (typical)	< 850 fs rms (typical)	< 850 fs rms (typical)	< 850 fs rms (typical)
Crossing point adjustment	40% to 60%	40% to 60%	40% to 60%	40% to 60%
Programmable de-emphasis	2 pre taps, 1 post tap	2 pre taps, 1 post tap	2 pre taps, 1 post tap	2 pre taps, 1 post tap
Polarity inversion	Yes	Yes	Yes	Yes

Clock Output	1001	1005	1001	1005
Rf output	Single-ended SMA	-	Single-ended SMA	-
Impedance	50 ohms	-	50 ohms	-
Half rate clock	1 to 15 GHz	-	1 to 15 GHz	-
Intrinsic jitter	< 350 fs rms (typical)	-	< 350 fs rms (typical)	-
Output amplitude	200 mV to 500 mV	-	200 mV to 500 mV	-

BERT TECHNICAL SPECIFICATIONS

Divided Clock Output	1001	1005	1001	1005
Rf output	Single-ended SMA	Single-ended SMA	Single-ended SMA	Single-ended SMA
Impedance	50 ohms	50 ohms	50 ohms	50 ohms
Frequency	500 MHz to 8 GHz	100 - 156.25 MHz Programmable Synthesizer Reference Out	500 MHz to 8 GHz	100 - 156.25 MHz Programmable Synthesizer Reference Out
Intrinsic jitter	< 350 fs rms (typical)	TBD	< 350 fs rms (typical)	TBD
Output amplitude	500 mV (typical)	700 mV (typical)	500 mV (typical)	700 mV (typical)
Selectable clock divider	Divide by n, with n = 2,4,8, 16	Divide by n, with n = 2,4,8	Divide by n, with n = 2,4,8, 16	Divide by n, with n = 2,4,8

Clock and Data Recovery	1001	1005	1001	1005
Data rate	6.15 to 7.25 Gbps, 12.3 to 14.5 Gbps, and 24.6 to 29 Gbps	1.25 to 14.5 Gbps	6.15 to 7.25 Gbps, 12.3 to 14.5 Gbps, and 24.6 to 29 Gbps	1.25 to 14.5 Gbps
Loop bandwidth	FC/1667 default, tunable 1 to 23 MHz	Tunable 6 to 10 MHz	FC/1667 default, tunable 1 to 23 MHz	Tunable 6 to 10 MHz
CDR output	Yes	No	Yes	No

Breakout Cables	1001	1005	1001	1005
Length	30 cm	30 cm	30 cm	30 cm
Connectors	2.92 mm, Male	SMA, Male	2.92 mm, Male	SMA, Male
Skew	< 2 ps skew match	< 2 ps skew match	< 2 ps skew match	< 2 ps skew match

Error Detector	1001	1005	1001	1005
Number of channels	2	4	2	4
RF input	AC coupled differential	AC coupled differential	AC coupled differential	AC coupled differential
Impedance	100 ohms between differential outputs	100 ohms between differential outputs	100 ohms between differential outputs	100 ohms between differential outputs
Data rate	12.3 to 14.5 Gbps, and 24.6 to 29 Gbps	1.25 Gbps to 14.50 Gbps	12.3 to 14.5 Gbps, and 24.6 to 29 Gbps	1.25 Gbps to 14.50 Gbps
Data rate step size	1 kbps	2 kbps	1 kbps	2 kbps
PRBS patterns	2n-1, n = 9, 15 or 31	2n-1, n = 7, 9, 10, 11, 15, 23 or 31	2n-1, n = 9, 15 or 31	2n-1, n = 7, 9, 10, 11, 15, 23 or 31
Sensitivity	25 mV	25 mV	25 mV	25 mV
Max input	1200 mV	1000 mV	1200 mV	1000 mV
Clock source	Independent CDR on each input channel	Independent CDR on each input channel	Independent CDR on each input channel	Independent CDR on each input channel
Polarity inversion	Yes	Yes	Yes	Yes
Equalizer	Programmable linear input CTLE equalizer 0 to 12 dB	Programmable linear input CTLE equalizer	Programmable linear input CTLE equalizer 0 to 12 dB	Programmable linear input CTLE equalizer
Eye contours	Eye Scan	3D Eye Monitor on each input to allow advanced measurements such as BER contours and eye parameters	Eye Scan	3D Eye Monitor on each input to allow advanced measurements such as BER contours and eye parameters

ORDERING INFORMATION



ACCESSORIES

- BERT-9005-1** = Replacement 30cm cable, ± 2 ps phase matching between differential pairs, SMA RF connectors.
BERT-9006-1 = Replacement 60cm cable, ± 2 ps phase matching between differential pairs, SMA RF connectors.
BERT-9007-1 = Replacement 30cm 1x8 2.92mm male breakout cable for BERT-1001.
BERT-9008-1 = Replacement 60cm 1x8 2.92mm male breakout cable for BERT-1001.
BERT-9101-1 = Insertion and extraction tool for wiring harness. Suitable for use with BERT-1005. Compact hand-held version.
BERT-9102-1 = Insertion and extraction tool for wiring harness. Suitable for use with BERT-1005. Ratchet style tool with handle.

WARRANTY INFORMATION

This product comes with a standard 1 year warranty.

EXTENDED WARRANTIES AND CALIBRATION PLANS

With an **extended warranty and calibration plan** you'll spend more time focused on your priorities and less time worrying about maintenance.

Your choice: add a **3 or 5 year extended warranty** when you buy.



Guarantee performance

Ensure your equipment is operating at the best it can be for reliable and accurate results.

Lower cost of ownership

Lock in savings and maximise your testing budget with a lower base cost of ownership.

Peace of mind

Spend less time worrying about maintenance and more on generating results.

CALIBRATION PLANS FOR ADDITIONAL DISCOUNTS

Order a **calibration plan** when purchasing your Quantifi Photonics instruments and get additional discounts.

10% Discount

On calibrations ordered at the time of purchase.

25% Discount

Add on an extended warranty and receive a 25% discount on calibrations.

Over time and with regular use, all optical parts and connectors require re-calibration and maintenance to guarantee accurate and reliable performance. We recommend Quantifi Photonics optical instruments are re-calibrated every 12 months. With an instrument calibration performed by Quantifi Photonics technicians you receive:

- Comprehensive calibration to factory specifications
- End-to-end inspection to ensure all instrument functions are working and connectors are clean
- Firmware, software and documentation updates
- Certificate of calibration which includes detailed test results

How to do I secure my extended warranty or calibration plan?

Contact your Quantifi Photonics sales representative or email sales@quantifiphotonics.com

Extended warranties and calibration plans must be ordered at the time of purchase and are available only for Quantifi Photonics' products. The 25% calibration discount only applies to calibrations while the product is covered by the extended warranty period.

Our portfolio of optical & electro-optical test modules is rapidly expanding to meet a wide range of customer requirements and applications.

Tunable Laser Sources

Versatile telecom laser sources with full tunability across C or L bands. Narrow 100 kHz linewidth, up to 16.5 dBm of power, optional whisper mode to disable frequency dither.



Fixed Wavelength Laser Sources

Highly customizable DFB or FP laser sources available in a wide range of wavelengths and powers. Models support SMF, MMF and PMF.



Swept, Tunable Continuous Wave Laser

Swept, tunable continuous wave (CW) laser source with 0.01 dB power stability and 400 nm/s high-speed scan rate for R&D and production testing.



Superluminescent Diode Broadband Light Source

Super-luminescent LED light source with high output power, large bandwidth and low spectral ripple and various wavelengths.



Erbium-Doped Fiber Amplifier (EDFA)

High power Erbium-Doped Fiber Amplifier for signal power amplification in C and L bands with various control modes, including automatic gain control.



Variable Optical Attenuator (VOA)

Fast attenuation speed with low insertion loss and built-in power monitoring. Operates in fixed attenuation or constant output power modes. Models support SMF, MMF and PMF connector types.



Polarization Controller & Scrambler

High-speed automated polarization control with broad wavelength coverage from 1260nm to 1650nm, low insertion loss and back reflection. Full remote control via intuitive GUI, LabVIEW or SCPI.



Optical-to-Electrical Converter

High bandwidth, broadband O-to-E converter. Available in a range of configurations; choose from 1 or 2 channels, AC or DC coupling and various conversion gain and operating wavelength ranges.



Optical Switch

Proven reliability and fast switching time. Wide variety of switch configurations: 1x4, 1x16, 16x16 and more. Models support SMF, MMF and PMF.



Optical Spectrum Analyzer (OSA)

Low cost, spectral measurement in a compact module with built-in analysis for: SMSR, OSNR & spectral width. Targeted wavelengths for specific applications in O band, C band & L band.



Optical Power Meters

Fast terminating or inline monitoring of optical signal power from -60 to +10 dBm across 750 - 1700 nm wavelengths. Model with logarithmic analog output for applications such as silicon photonics fiber alignment.



Bit Error Rate Tester (BERT)

2, 4 or 8-channel Pulse Pattern Generator and Error Detector at rates up to 29 Gbps for the design, characterization and production of optical transceivers and opto-electrical components.



Photonic Doppler Velocimeter (PDV)

Purpose-built module for Photonic Doppler Velocimetry (PDV). A circulator, two VOAs and a passive coupler all built into one compact module.



Passive Component Integration

Integrate passive optical components of your choice such as WDM couplers, splitters, band-pass filters, PM beamsplitters and circulators. Models support SMF, MMF and PMF.



Passive Component Storage

Protect and store your own passive fiber optic components such as splitters, connector adaptor patchcords, WDM couplers, and isolators in one handy module.



PXI – MODULAR SYSTEM

MATRIQ – COMPACT BENCHTOP

See our website for more details
quantifotonics.com/products

Test. Measure. Solve.TM

Quantifi Photonics is transforming the world of photonics test and measurement. Our portfolio of optical and electrical test instruments is rapidly expanding to meet the needs of engineers and scientists around the globe. From enabling ground-breaking experiments to driving highly efficient production testing, you'll find us working with customers to solve complex problems with experience and innovation.

To find out more, get in touch with us today.



General Enquiries
Technical Support
Phone
North America

sales@quantifiphotonics.com
support@quantifiphotonics.com
+64 9 478 4849
+1-800-803-8872

Contact in France :

WAVETEL PARIS | RENNES | LARMOR-PLAGE | LANNION
sales@wavetel.fr - www.wavetel.fr - +33(0)2 99 14 69 65



quantifiphotonics.com

QUANTIFI
PHOTONICS®